

NI PXI-2555 Specifications

2.5 GHz 75 Ω Terminated 4 x 1 Multiplexer (SP4T)

このドキュメントには、日本語ページも含まれています。

This document lists specifications for the NI PXI-2555 multiplexer module. All specifications are subject to change without notice. Visit ni.com/manuals for the most current specifications.

Topology Terminated 4 x 1 multiplexer

Refer to the *NI Switches Help* for detailed topology and front panel connector information.



Caution To ensure the specified EMC performance, operate this product only with shielded cables and accessories.



Caution Device relays might change state momentarily during electrostatic discharge.



Caution Refer to the *Read Me First: Safety and Electromagnetic Compatibility* document at ni.com/manuals for important safety and compliance information.

About These Specifications

Specifications characterize the warranted performance of the instrument under the stated operating conditions.

Typical Specifications are specifications met by the majority of the instrument under the stated operating conditions and are tested at 23 °C. Typical specifications are not warranted.

Input Characteristics

All input characteristics are DC, AC_{rms}, or a combination unless otherwise specified.

Maximum switching voltage 30 V

Maximum switching current 0.5 A
(per channel)

Maximum carry current 0.5 A
(per channel)

Maximum RF power
Channel to common 10 W
Termination (≤ 25 °C ambient) 1.5 W
(See Figure 5 for derating.)



Caution The switching power is limited by the maximum switching current and the maximum voltage. Channel to common switching power must not exceed 10 W.



Caution Terminations cannot withstand the full rated power of the NI PXI-2555.



Note National Instruments recommends against switching active RF signals. As a relay actuates, the channel is momentarily unterminated. Some RF sources can be damaged by reflections if their outputs are not properly terminated. Refer to your RF source documentation for more information.

Typical DC path resistance

Initial $< 0.35 \Omega$

End-of-life $\geq 1.0 \Omega$

Path resistance is a combination of relay contact resistance and trace resistance. Contact resistance typically remains low for the life of a relay. At the end of relay life, the contact resistance rises rapidly above 1.0 Ω .

RF Performance Characteristics

Characteristic impedance (Z_0)75 Ω nominal

Values in parentheses are typical.

Insertion loss

- ≤1 GHz<1.1 dB (<0.65 dB)
- ≤2 GHz<1.7 dB (<1.30 dB)
- ≤2.5 GHz<2.0 dB (<1.65 dB)

Voltage standing wave ratio (VSWR), channel to common

- ≤1 GHz<1.3 (<1.2)
- ≤2 GHz<1.65 (<1.35)
- ≤2.5 GHz<1.75 (<1.5)

Typical isolation

- ≤1 GHz>49 dB
- ≤2 GHz>45 dB
- ≤2.5 GHz>43 dB

Typical channel-to-channel skew<30 ps

Typical propagation delay1.2 ns

Typical rise time (10% to 90%)90 ps

Refer to Figures 1, 2, 3, and 4 for typical insertion loss, typical channel to common VSWR, typical termination VSWR, and typical isolation, respectively.

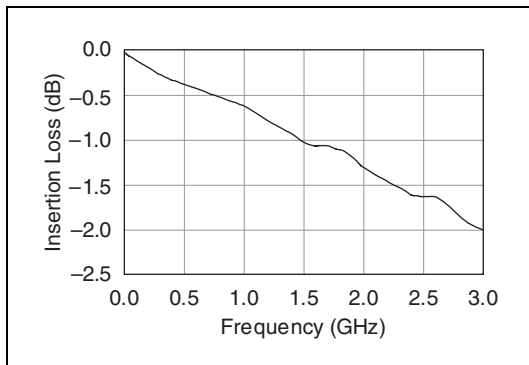

Figure 1. Typical Insertion Loss

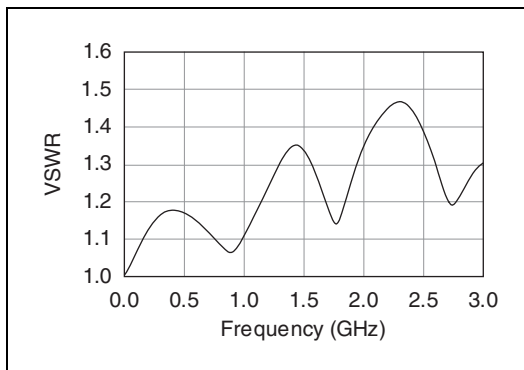

Figure 2. Typical Channel to Common VSWR

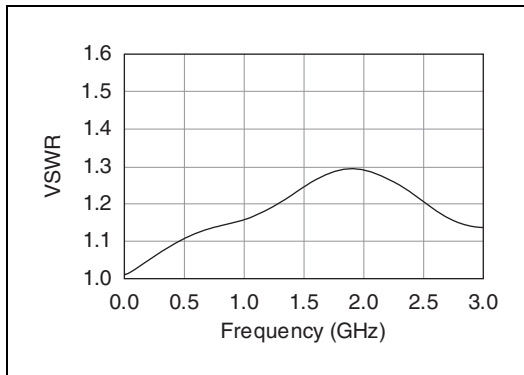

Figure 3. Typical Termination VSWR

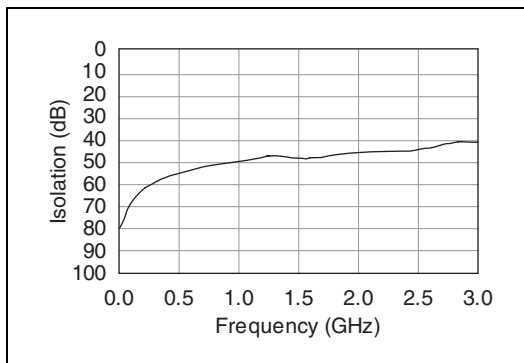

Figure 4. Typical Isolation

Termination Derating



Caution When operating the PXI-2555 at ambient temperatures $>25^{\circ}\text{C}$, the derating in Figure 5 limits the maximum constant power each termination can dissipate.

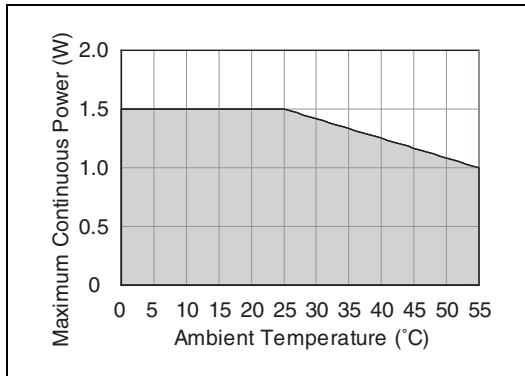

Figure 5. Termination Derating



Caution Failure to operate below listed power limits can result in permanent damage to the module.

Dynamic Characteristics

Maximum relay operate time 10.4 ms



Note Certain applications may require additional time for proper settling. For information about including additional settling time, refer to the *NI Switches Help*.

Maximum scan rate 45 channels/s

Expected relay life

Mechanical 1×10^6 cycles

Electrical 3×10^5 cycles
(30 V, 10 mA, DC resistive)

Trigger Characteristics

Input trigger

Sources PXI trigger lines 0–7

Minimum pulse width 150 ns



Note The NI PXI-2555 can recognize trigger pulse widths less than 150 ns by disabling digital filtering. For information about disabling digital filtering, refer to the *NI Switches Help*.

Output trigger

Destinations PXI trigger lines 0–7

Pulse width Programmable
(1 μs to 62 μs)

Physical Characteristics

Relay type Electromechanical,
latching

I/O connectors 5 mini-75 Ohm SMB
jacks, gold plated

PXI power requirement 3.7 W at 5 V,
0.3 W at 3.3 V

Dimensions (L \times W \times H) 3U, one slot,
PXI/cPCI module
21.6 \times 2.0 \times 13.0 cm
(8.5 \times 0.8 \times 5.1 in.)

Weight 218 g (7.7 oz)

Environment

Operating temperature 0°C to 55°C

Storage temperature -20°C to 70°C

Relative humidity 5% to 85%,
noncondensing

Pollution Degree 2

Maximum altitude 2,000 m

Indoor use only.

Shock and Vibration

Operational Shock 30 g peak, half-sine,
11 ms pulse
(Tested in accordance
with IEC-60068-2-27.
Test profile developed
in accordance with
MIL-PRF-28800F.)

Random Vibration

Operating 5 to 500 Hz, 0.3 g_{rms}

Nonoperating 5 to 500 Hz, 2.4 g_{rms}

(Tested in accordance
with IEC-60068-2-64.
Nonoperating test profile
exceeds the requirements
of MIL-PRF-28800F,
Class 3.)

Accessories

Visit ni.com for more information about the following accessories.

Table 1. NI Accessories for the NI PXI-2555

Accessory	Length	Part Number
Mini-75 Ohm SMB plug to mini-75 Ohm SMB plug coaxial cable	0.3 m	197211-0R3
	1.0 m	197211-01
Type F female to mini-75 Ohm SMB plug coaxial cable	0.3 m	197210-0R3

Figure 6 shows the NI PXI-2555 power-on state.

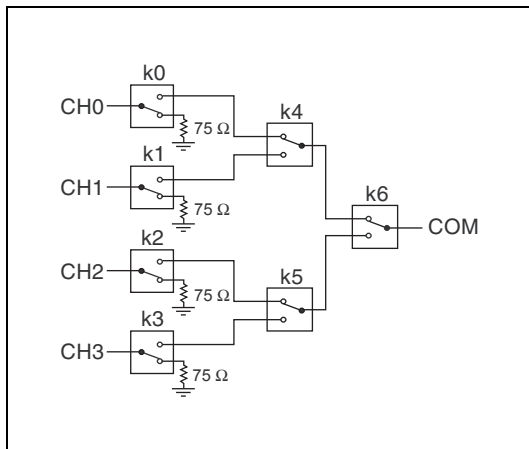

Figure 6. NI PXI-2555 Power-On State

Figure 7 shows the NI PXI-2555 front panel connector.

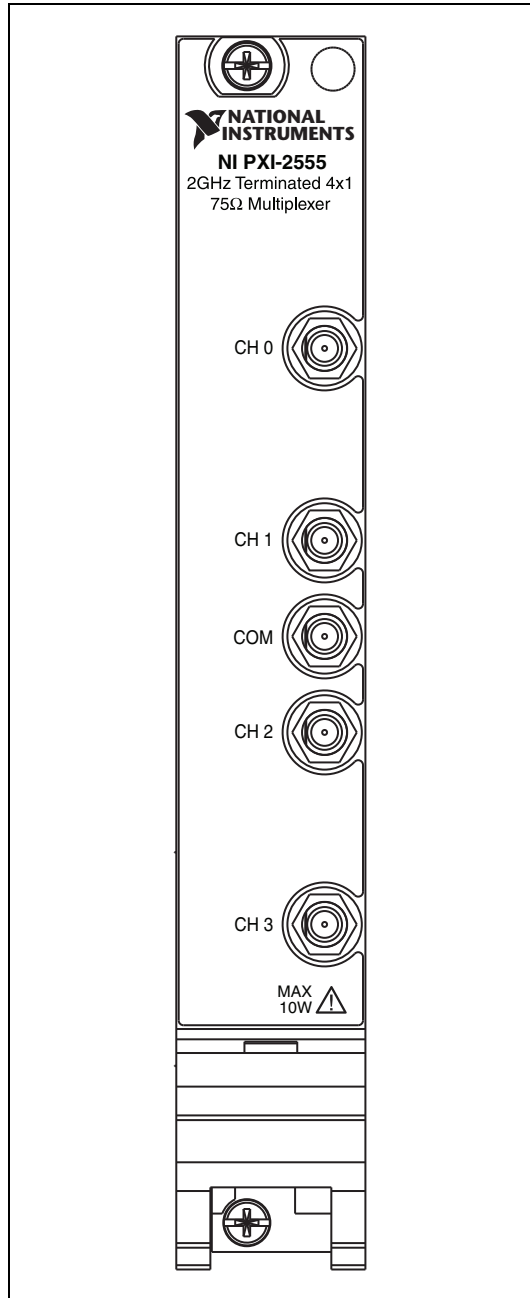

Figure 7. NI PXI-2555 Front Panel Connector

Compliance and Certifications

Safety

This product meets the requirements of the following standards of safety for electrical equipment for measurement, control, and laboratory use:

- IEC 61010-1, EN 61010-1
- UL 61010-1, CSA 61010-1



Note For UL and other safety certifications, refer to the product label or the *Online Product Certification* section.

Electromagnetic Compatibility

This product meets the requirements of the following EMC standards for electrical equipment for measurement, control, and laboratory use:

- EN 61326-1 (IEC 61326-1): Class A emissions; Basic immunity
- EN 55011 (CISPR 11): Group 1, Class A emissions
- AS/NZS CISPR 11: Group 1, Class A emissions
- FCC 47 CFR Part 15B: Class A emissions
- ICES-001: Class A emissions



Note For EMC declarations and certifications, refer to the *Online Product Certification* section.

CE Compliance

This product meets the essential requirements of applicable European Directives as follows:

- 2006/95/EC; Low-Voltage Directive (safety)
- 2004/108/EC; Electromagnetic Compatibility Directive (EMC)

Online Product Certification

To obtain product certifications and the Declaration of Conformity (DoC) for this product, visit ni.com/certification, search by model number or product line, and click the appropriate link in the Certification column.

Environmental Management

NI is committed to designing and manufacturing products in an environmentally responsible manner. NI recognizes that eliminating certain hazardous substances from our products is beneficial to the environment and to NI customers.

For additional environmental information, refer to the *NI and the Environment* Web page at ni.com/environment. This page contains the environmental regulations and directives with which NI complies, as well as other environmental information not included in this document.

Waste Electrical and Electronic Equipment (WEEE)



EU Customers At the end of the product life cycle, all products *must* be sent to a WEEE recycling center. For more information about WEEE recycling centers, National Instruments WEEE initiatives, and compliance with WEEE Directive 2002/96/EC on Waste Electrical and Electronic Equipment, visit ni.com/environment/weee.

电子信息产品污染控制管理办法（中国 RoHS）



中国客户 National Instruments 符合中国电子信息产品中限制使用某些有害物质指令 (RoHS)。关于 National Instruments 中国 RoHS 合规性信息, 请登录 ni.com/environment/rohs_china。(For information about China RoHS compliance, go to ni.com/environment/rohs_china.)

LabVIEW, National Instruments, NI, ni.com, the National Instruments corporate logo, and the Eagle logo are trademarks of National Instruments Corporation. Refer to the *Trademark Information* at ni.com/trademarks for other National Instruments trademarks. Other product and company names mentioned herein are trademarks or trade names of their respective companies. For patents covering National Instruments products/technology, refer to the appropriate location: **Help»Patents** in your software, the `patents.txt` file on your media, or the *National Instruments Patent Notice* at ni.com/patents. Refer to the *Export Compliance Information* at ni.com/legal/export-compliance for the National Instruments global trade compliance policy.